

 TREASURE GARDEN

AG19 10'oc **Cantilever**

Assembly and Operation Guide

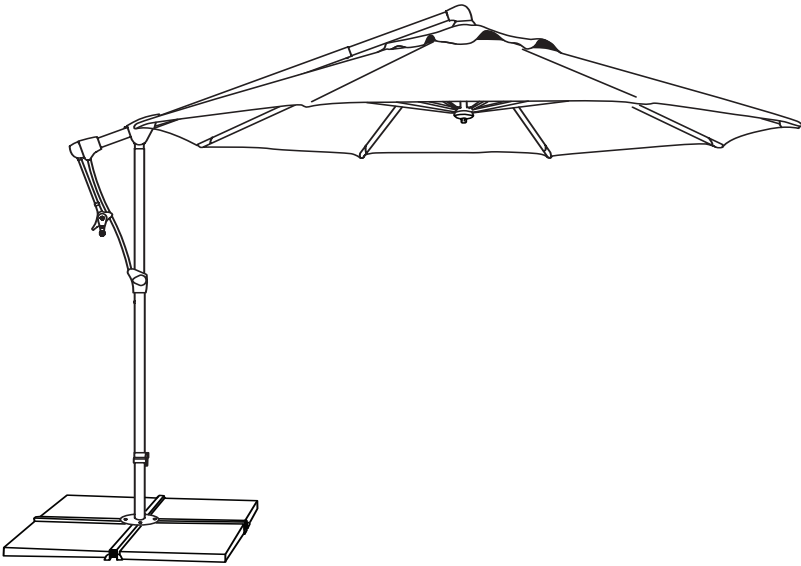

Compliments of www.poolsandstuff.com

Thank you for your purchase of Treasure Garden's AG19 Cantilever Umbrella.

Please remove all contents from the package, inspect and review checklist.

CAUTION: To reduce personal injury and damage to your AG19, read and follow this assembly and operation guide. We recommend a two-person team for assembly and disassembly. *Save information for future reference.*

AG19 CHECKLIST

- | | | |
|----------------------|-----------------------|-------------------------|
| A - Spring Locks (2) | G - Support Strut | M - Cantilever Arm |
| B - Top Pole | H - Tilt Degree Scale | N - Hinge |
| C - Crank | I - Shoulder | O - Vega™ Light Adapter |
| D - Operating Handle | J - Release Knob | P - Canopy |
| E - Crank Case | K - Bottom Pole | Q - Cross Bars (2) |
| F - Steering Rod | L - Base Pole Clamp | R - Bottom Pole Stem |

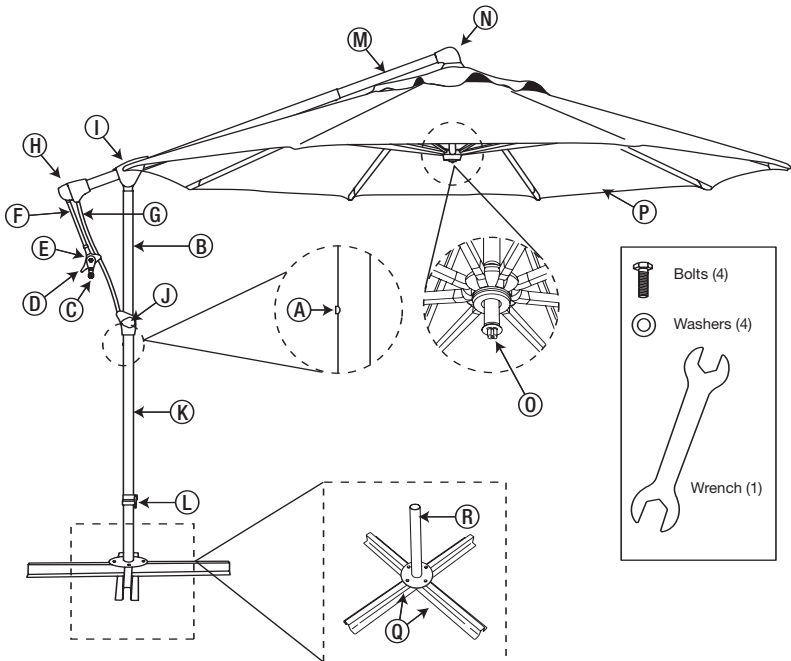

REQUIRED FOR ASSEMBLY:

- One (1) 1/2" socket wrench or adjustable wrench.
- Four (4) 40 lb. weights - square stones or concrete weights. (160 lb. total weight needed for support - **weights not included**) Stones & weights, standard sizes can be used up to 20" L x 20" W x 1.5" H.

NOTE: Using the cross bar stand without weights will damage your umbrella and may cause injury.

STEP 1 Assemble Cross Bar Stand

Set cross bars in a cross position and attach bottom pole stem (Fig. 1) to cross bar stand with supplied bolts and washers (Fig. 2). Secure with (4) square stones or concrete weights (weights not included).

IMPORTANT: Cross bar stand will not support umbrella without proper weights. Using the stand without weights will damage your umbrella.

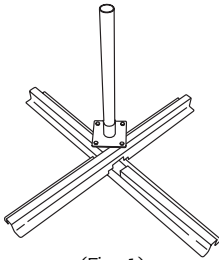

(Fig. 1)

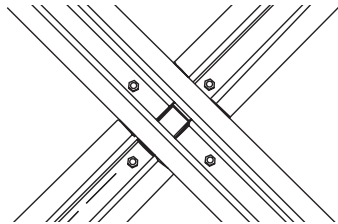

(Fig. 2)

STEP 2 Assemble AG19 Frame

Insert the top pole with canopy into the bottom pole until spring locks (Fig. 3). Hold the canopy closed and slowly lift cantilever upwards until arm is fully extended and spring locks into place (Fig. 4). Screw the crank handle dockwise into the crank case.

***NOTE:** Shortening of the cantilever is merely for packaging purposes or storage.

IMPORTANT: (If cantilever arm does not fully extend, cord may be coiled too tightly). Two persons are needed for the following action. While the first person slowly lifts the cantilever up, the second person turns the crank handle counter-clockwise, releasing more cord to allow the cantilever arm to raise until spring locks into place.

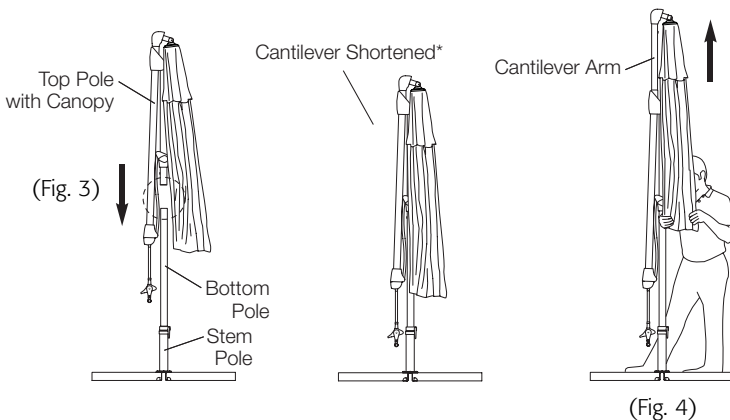

Cantilever Shortened*

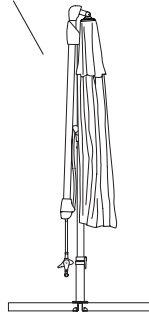

Cantilever Arm



STEP 3 Opening AG19

Hold the tilt degree handle (Fig. 6) on the cantilever and push it up until the shoulder is reached. Lock the umbrella by attaching the crank case to the support strut (Fig. 7). Turn the crank (Fig. 8) clockwise  until the umbrella is fully opened and the hub (Fig. 9) is at the top most position.

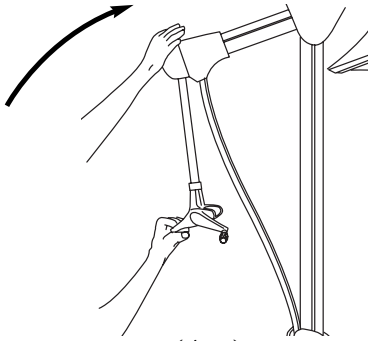

(Fig. 6)

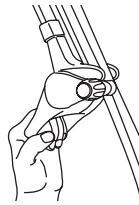

(Fig. 7)



(Fig. 8)

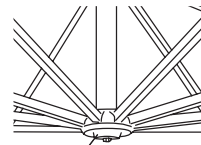



Slider

(Fig. 9)

STEP 4 Closing AG19

IMPORTANT: When closing the umbrella, the canopy must be in a horizontal position, or damage to umbrella may occur.

Hold the operating handle against supporting strut and turn the crank counter-clockwise  (Fig. 10) until the canopy is closed. Unlock the umbrella by detaching the crank case from the support strut (Fig. 11). Turn the release knob (Fig. 12) clockwise;  at the same time, pull the cantilever back by holding the tilt degree scale (Fig. 13) and guide the cantilever back to the pole. **CAUTION:** Avoid pinching hands or fingers while closing the umbrella. Once umbrella is closed, cover it with a protective cover (sold separately).



(Fig. 10)

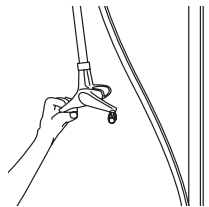

(Fig. 11)

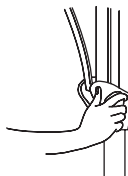

(Fig. 12)

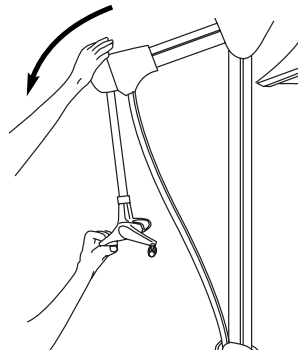

(Fig. 13)

STEP 5 Turning AG19 Around the Pole Axis

Loosen the base pole clamp by turning the clamp counter-clockwise. Turn the umbrella to the desired position. Turn the clamp in a clockwise direction, to tighten.

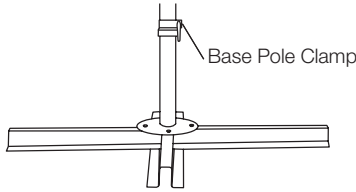

STEP 6 Adjusting the Tilt

Pull the operating handle from the support strut (Fig. 12). Pull the steering rod further away from the support strut (to a 45° angle) until the steering rod is in the **marked range** (Fig. 13). While still in the marked range, rotate the steering rod to the left or right (Fig. 14), to the angle you wish to tilt. Push the operating handle straight forward, then bring it back to center position and lock the crank case onto the support strut (Fig. 15). Your canopy should now be locked into its tilted position (Fig. 16).

NOTE: If you wish to rotate the canopy 15° clockwise, then rotate the steering rod 15° counter-clockwise.

To return canopy to its horizontal position (which **MUST** be done before closing the umbrella) simply do these steps in reverse. Start by pulling the operating handle slightly away from the support strut, but **NOT** into the marked range. Rotate the canopy back to horizontal, then pull the steering rod into the marked (release) range; which will allow the steering rod to move freely back to the center position.

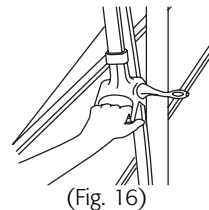
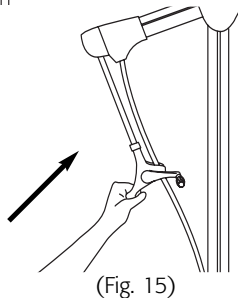
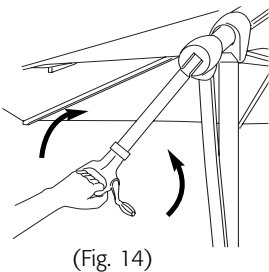
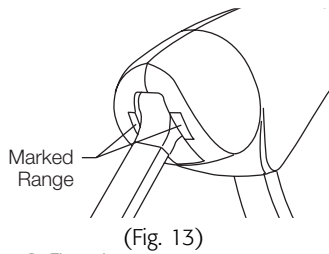
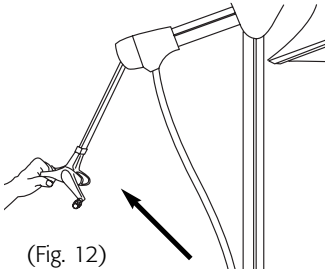

AG19 Features

To ATTACH VEGA Umbrella Light:

Loosen the VEGA light adapter built into the umbrella runner by turning counter-clockwise  (Fig. 17). After loosening, pull down light adapter post (Fig. 18) to attach the VEGA umbrella light (sold separately).

To OPEN and ATTACH VEGA:

Open the VEGA umbrella light by holding firmly with one hand and then depress the damp release button with the other hand to release the damp lock. Open up the VEGA light and clasp around the light adapter post (Fig. 19). Snap to close (Fig. 20).

To REMOVE VEGA and CLOSE adapter:

Hold the VEGA umbrella light, depress the damp release button to release the damp lock. Remove VEGA umbrella light, and gently push up the light adapter post back into umbrella runner and tighten turning clockwise .

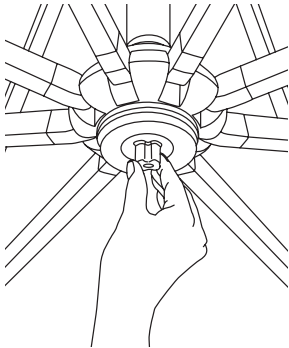

(Fig. 17)

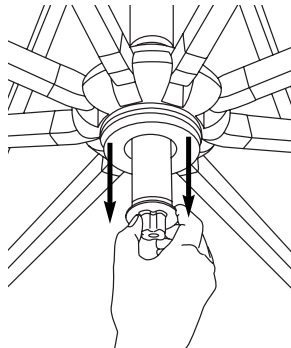

(Fig. 18)

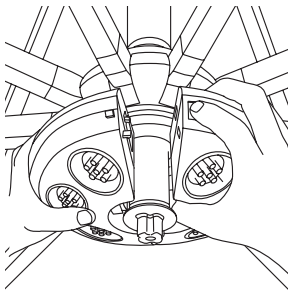

(Fig. 19)

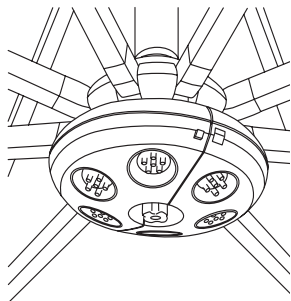

(Fig. 20)

WARRANTY:

Treasure Garden warrants this product (in residential use) to be free from defects in original materials and workmanship for a period of 1 year from the date of purchase. If a defect in the original material or workmanship appears during the warranty period; Treasure Garden will (at its option) repair or replace the product without charge. Limited warranty against fabric fading, based on fabric grade.

Simply contact your original authorized Treasure Garden dealer with a description of the defect. The dealer will verify the defect and work closely with Treasure Garden to obtain the necessary service. In many cases, simple problems can be solved with a replacement part that can be shipped directly to the dealer for professional installation/repair.

In the event that warranted factory service is required, Treasure Garden will assume the responsibility of the return freight charges on warranted product for the first year only.

Returned product that (upon receipt and inspection) is deemed to be "not covered" under our warranty, will be shipped/billed at your expense.

This warranty gives you specific legal rights, and you may have other rights which vary from state to state.

NOTE: Failure caused by unreasonable or abusive use, or failure caused by neglect of reasonable and necessary care are not covered by this warranty.

Additionally, acts of nature (including but not limited to wind, hurricanes, tornadoes, and storms) are not covered by this warranty.

S A F E T Y P R E C A U T I O N S :

- Close the umbrella in windy conditions or when a storm approaches. Never allow the umbrella to flap in the wind; this could damage the canopy.
- Do not leave open umbrella unattended. If damage occurs, this is not covered by the warranty.
- When adjusting the umbrella, make sure that no person(s) or item(s) are close to the umbrella. This is important to prevent injury or material damage.

C A R E A N D M A I N T E N A N C E :

- When not in use, close and cover umbrella with a protective cover (sold separately).
- Allow a wet canopy to dry opened up.
- If necessary, clean the fabric with lukewarm water, mild detergent, and a sponge.
- Wipe sliding marks on the aluminum poles with a damp cloth.

Winter Storage:

- Store in a dry, protective place.
- Any visible defects must be repaired by a professional.

After the Winter:

- Areas subject to turning and sliding can be treated with a non-staining lubricant spray (silicone-based).
- Check the condition and function of the umbrella. Any defects must be repaired by a professional.



www.treasuregarden.com

©2011 Treasure Garden, Inc. - All Rights Reserved.

Initial 3/11